

veritas[®]
Cabinet Scraper



05P32.05

The Veritas® Cabinet Scraper is a very versatile tool, capable of both rough and fine work. As supplied, both edges of the blade are ground at 45° and need only burnishing for rough work such as removing paint, glue squeeze-out prior to planing, dirt or old finish. By honing the blade before burnishing the edges, the scraper can be used to smooth highly figured wood with no danger of tear-out, producing a surface that can rival a fine smoothing plane.

The double-edged blade halves the number of sharpening sessions. The handles are designed to allow an effective two-handed grip with the force of the stroke directly in line with the cutting edge.

The type of cutting action generated by this tool is ideal for hardwood but generally unsuitable for fine work on soft woods such as pine, butternut, basswood and cedar, although it will still be useful for rough work such as cleaning off glue.

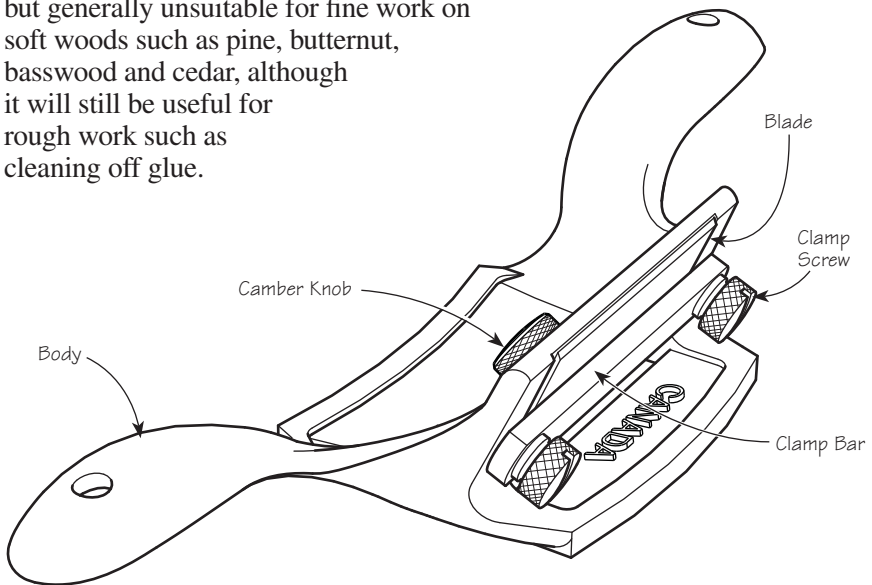

Figure 1: Cabinet scraper components.

Sharpening

Remove the lacquer coating on a new blade. The scraper blade is supplied with both its edges ground at 45°. Depending on the type of work you will be doing with the cabinet scraper and the condition of the blade, you may not need to follow all the steps detailed below. For example, if you wish to get started on rough work, go directly to *Step 3 — Burnishing*. For fine work with a new blade, start with *Step 2 — Honing*, but for sharpening a used blade, start with *Step 1 — Preparation*.

Step 1 — Preparation: This step is not necessary with a new blade. Before you start honing, the blade should be shaped to maintain a straight cutting edge and a 45° bevel. Hold the blade in a vise and use a 6" or 8" bastard cut mill file to prepare the blade. Check the bevel periodically with a straightedge and a protractor (or sliding bevel set to 45°) as you work. The Veritas Jointer/Edger (05M07.01) is ideal for this process. A bench-top belt sander with an 80x or 120x abrasive belt may also be used for this step. If you are planning to use the scraper for a rough job, you may now skip ahead to *Step 3 — Burnishing*. If the scraper is to be used for finer work, the next step explains how to hone the edge.

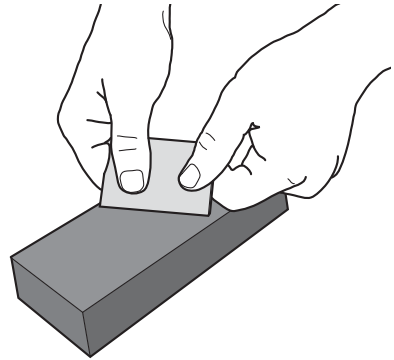

Figure 2: Honing.

Step 2 — Honing: Start with an 800x or 1000x stone to remove the marks from filing. Either an oil stone or water stone is suitable. Hold the blade as shown in **Figure 2** with the bevel flat against the stone. Stroke it back and forth, covering the whole stone. Check the bevel often to evaluate your progress. Continue until all file marks are gone. As shown in **Figure 3**, lap the face of the blade near the cutting edge to achieve the same finish as on the bevel. A sharp edge can only be achieved by creating two intersecting surfaces honed to the same degree. (If the scraper is to be used for general smoothing and not for fine finishing, it may now be burnished.) Using the same technique, transfer to a 4000x water stone or hard Arkansas oil stone to finish honing. A bench-top belt sander with 320x (40 μ) followed by 1200x (9 μ) abrasive belt will provide the same results a bit faster.

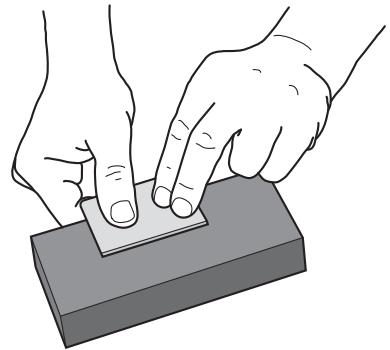

Figure 3: Lapping.

Step 3 — Burnishing: With the blade held firmly in a vise, use a burnisher (the Veritas Tri-Burnisher 05K32.01 is well suited) to create a hook as shown in **Figure 4**. Use three or four firm strokes at the same angle as the bevel. Raise the burnisher handle slightly and take three or four more strokes. Finish by taking three or four strokes with the burnisher 15° from horizontal as shown in **Figure 4**. The first few times you do this, sight against a reference tool such as a sliding bevel or engineer’s protractor set to the desired angle.

Note: Before burnishing, it never hurts to touch your finger tip to the side of your nose or behind your ear (two natural oil sources) and transfer that minute amount of oil to the blade. It reduces friction and avoids galling.

Blade Adjustment

Set up the blade as shown in **Figure 5**. Back off the camber knob to retract it from the blade bed, so it will be out of the way while the blade is being clamped. Place the body on a flat surface, such as a workbench, and insert the blade, with the cutting edge in contact with the workbench, and tighten both clamp screws. The bevel must be oriented as illustrated in **Figure 5**. Turn the camber knob until it contacts the blade. Sight along the sole. The blade should appear as a slight curve, projecting in the middle as shown in **Figure 6**. Ideally, the corners should not be visible. Take a few test strokes; adjust the camber knob as desired. The more pressure applied with the camber knob, the more aggressive the cut.

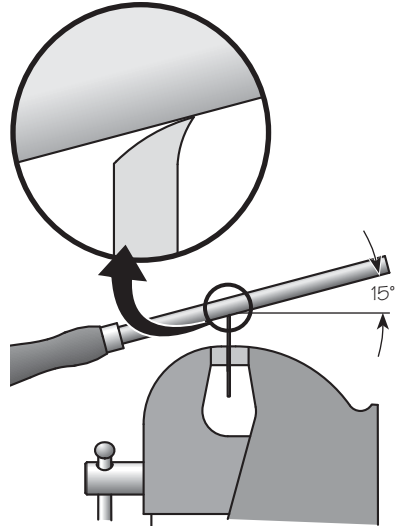

Figure 4: Burnishing.

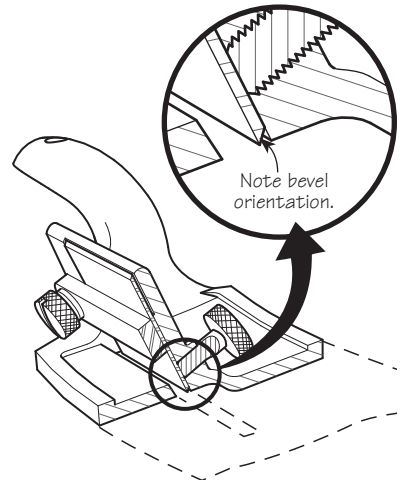

Figure 5: Set-up.

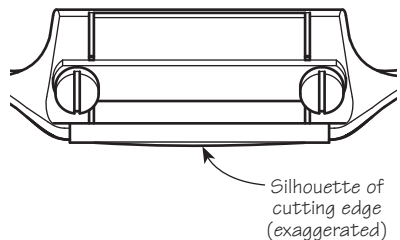

Figure 6: Adjustment.

Use

The scraper is designed to be used primarily on the push stroke as shown in **Figure 7**. If it is turned around, it may also be used with a pull stroke. When used for smoothing a board or panel, it is usually best to scrape the entire surface with a series of overlapping strokes.

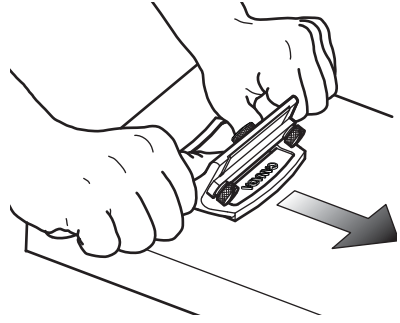

Figure 7: Hand position.

Troubleshooting

Problem	Solution
Hard to push. Cut too aggressive.	Blade projects too far. Back off camber knob. Reclamp blade.
A ridge or step is left on one side of the cut.	Blade is unevenly set (too low on one side). Reclamp blade.
Cutting action produces dust instead of shavings.	Blade is dull. Resharpener.
Scraped surface appears rough, covered with ridges and scratches.	Cutting edge not properly honed – scratches from coarse abrasive or file not removed in final stage of honing. Resharpener.
Blade will not cut.	Hook may be burnished too far. Try "picking up" the edge with the tip of an awl; otherwise, resharpen starting with <i>Step 1 — Preparation</i> .

Care and Maintenance

- The body of the scraper is made from cast ductile iron. This material is tougher and more stable than the more common and traditional gray iron. Although it will usually withstand hard knocks without material failure, avoid dropping the scraper on a hard surface such as a concrete floor.
- Never use the scraper as any sort of striking tool.
- Store in a dry place. The sole can rust if exposed to moisture or humid conditions. As with any iron body plane, an occasional application of paste wax will prevent rust.
- Avoid placing the scraper on the sole when not in use, to help maintain the cutting edge.
- Resharpen as described above.
- If water stones are used, be sure to remove all traces of water after sharpening. As with the sole, the blade can rust after the lacquer coating is removed. Paste wax or a similar product will help prevent corrosion.

Accessories

05P32.06 Replacement Blade

veritas[®] Tools Inc.

814 Proctor Avenue 1090 Morrison Drive
Ogdensburg NY 13669-2205 Ottawa ON K2H 1C2
United States Canada

customerservice@veritastools.com
www.veritastools.com